

IMPORTANT INSTALL NOTE

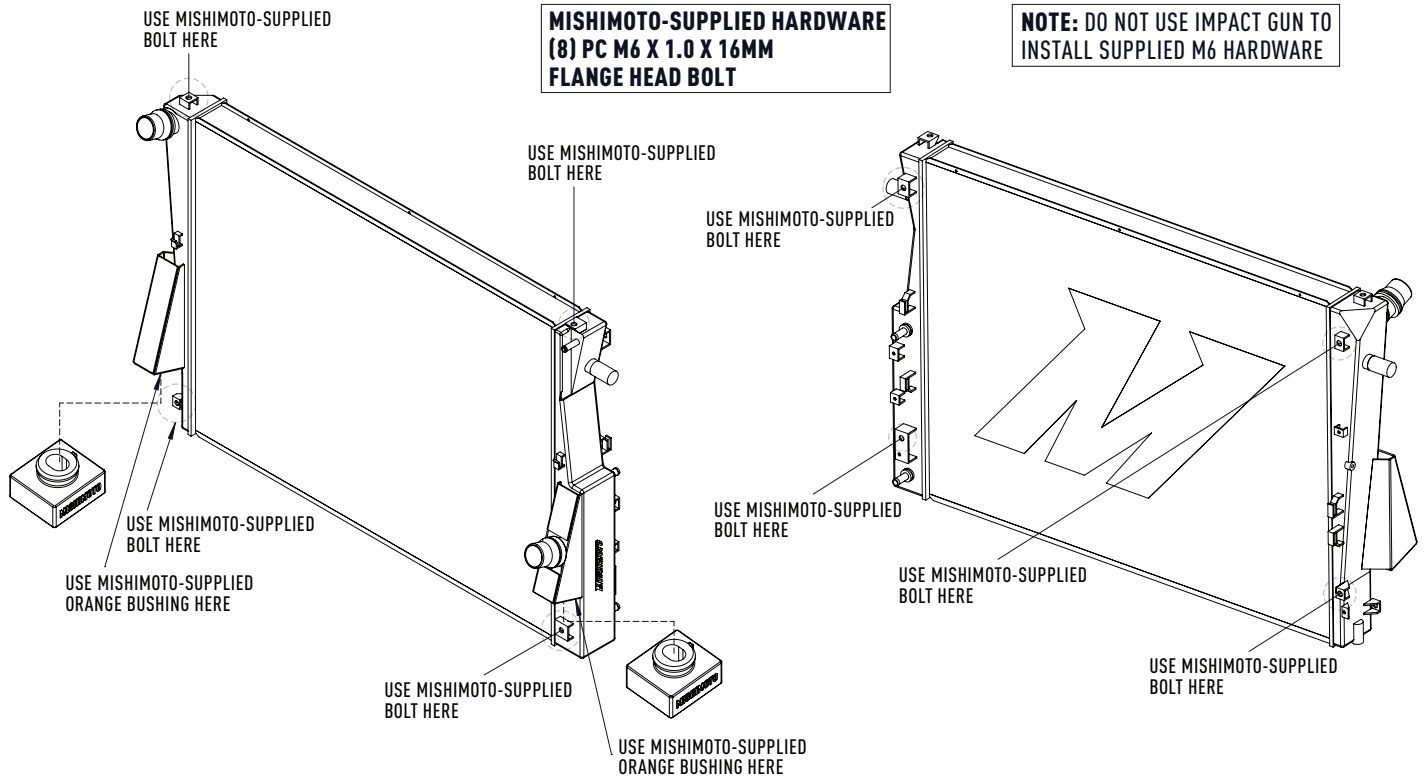

**MISHIMOTO-SUPPLIED HARDWARE
 (8) PC M6 X 1.0 X 16MM
 FLANGE HEAD BOLT**

**NOTE: DO NOT USE IMPACT GUN TO
 INSTALL SUPPLIED M6 HARDWARE**

MAKING OUR PRODUCTS BETTER

Every day at Mishimoto, our engineers are looking for ways to improve our products and ensure that you receive the highest quality part for your money. Every vehicle presents new challenges to overcome and opportunities to improve factory designs. That's why you'll find two new lower radiator bushings included with your 2008–2010 Ford 6.4L Powerstroke Aluminum Radiator. These new bushings replace the stock lower mounting bushings, providing extra support and safety for your new Mishimoto radiator.

Through our testing and customer feedback, we found that the 2008–2010 Ford F-Series trucks suffer from a large amount of frame twist and impact forces while driving over uneven surfaces. The Mishimoto radiator incorporates two key features to counteract this frame twist and impact: rubberized upper mounting pegs and upgraded lower mounting bushings. The upper mounting pegs allow for flex when the frame is twisting, which reduces stress on the radiator. The new lower bushings

raise the radiator slightly to close any gaps between the radiator and the mounting surface, cushioning impact forces caused by driving over uneven surfaces.

WARRANTY

Please also be aware that the installation of these bushings is **essential** in preventing damage to your new Mishimoto radiator and maintaining the radiator's Lifetime Warranty. Failure to install the provided Mishimoto lower radiator bushings will void the Mishimoto Lifetime Warranty. All claims for this product **(MMRAD-F2D-08V2)** must be accompanied with a picture of the Mishimoto lower radiator bushings installed on the vehicle.

We hope you enjoy your new Mishimoto radiator and, as always, feel free to contact our customer service at **1.877.GOMISHI** or email us at **support@mishimoto.com** if you need any help!

CONTINUED ON FOLLOWING PAGE

01

'08 –'10 FORD 6.4L POWERSTROKE ALUMINUM RADIATOR PRE-INSTALL RADIATOR CHECKLIST



PRE-INSTALL RADIATOR CHECKLIST

The 6.4 radiator is an integral piece of the cooling system, but it relies on chassis bushings and other cooling system components for optimal functionality and longevity. Our team has identified several vital upgrades and maintenance items that will directly impact the lifespan of your radiator. The list below provides guidelines regarding the necessary procedures for appropriate protection of your cooling system.

By following these guidelines you can extend the life of your radiator and cooling system and reduce vehicle downtime. This has been compiled in the best interest of our consumers, and its completion is necessary prior to the installation of any radiator, whether it be a factory unit or the Mishimoto radiator.

DEGAS BOTTLE

01. Confirm if the coolant Degas Bottle has been updated from the two-port design (**Figure 1**) to the single-port design (**Figure 2**). If this update has been performed, be sure the radiator cap has been replaced with the single-port unit.
02. If a single-port Degas Bottle is installed, check the cap for nicks or cracks. If the cap is damaged in any way, be sure to replace it.

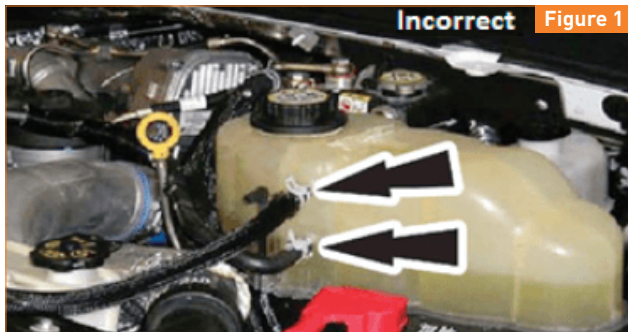

03. If a single port Degas Bottle is in place, ensure that the appropriate venturi tee connections (**Figure 3**) are being used.

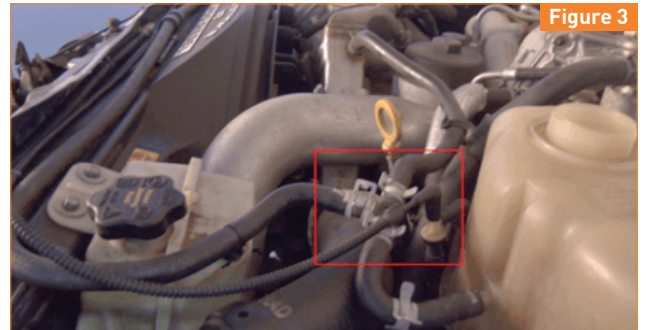

COOLANT LEAKS

04. Inspect all coolant hoses/components for leaks. Failed hose O-rings are quite common and are easily identified by a white residue (**Figure 4**). Failure-prone points include connections at the radiator and engine. If any form of leaking exists, replace the affected hose with the updated double O-ring design (**Figure 5**). If the hoses are removed for any reason, be sure to check the O-rings for damage prior to reinstallation.



CONTINUED ON FOLLOWING PAGE

02

'08 –'10 FORD 6.4L POWERSTROKE ALUMINUM RADIATOR PRE-INSTALL RADIATOR CHECKLIST

THERMOSTATS

05. Factory thermostats are prone to overextension, which results in thermal spikes within the radiator and potential damage. remove the factory thermostat housing and inspect the bypass thermostat for extension distance from the mounting surface (**Figure 6**). This distance should be no greater than 45mm. In the case if this distance is greater than 45mm, replace the thermostat.

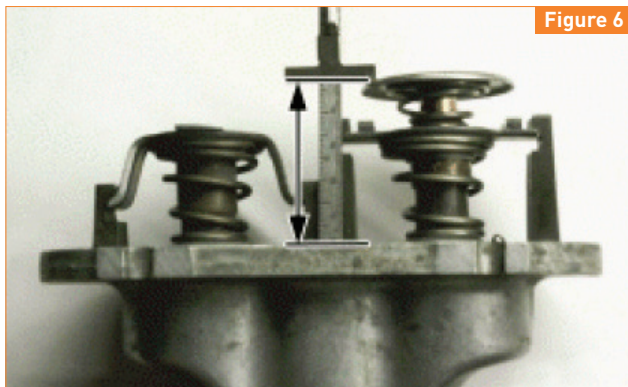

Figure 6

REFILLING COOLANT

06. When refilling the coolant system, be sure to use a radiator refiller such as the airlift refill Tool recommended by Ford. If this device is not used, air pockets in the system can exist resulting in low fluid levels.
07. Check the coolant level after a few cycles of bringing the truck to operating temperature and back to ambient. Proper coolant level is vital for this system; the fluid should be between the two lines on the Degas Bottle when the engine is cold. From our experience, obtaining the proper level of coolant and air pocket elimination will take approximately two to four warmup cycles.

BUSHING INSPECTION

08. Check the upper radiator mounting peg bushings for damage. These bushings (**Figure 7 and 8**) should be pliable and free of any cracking or tears. If these bushings are damaged, replace them with OEM components.



Figure 7



Figure 8

CONTINUED ON FOLLOWING PAGE

'08 –'10 FORD 6.4L POWERSTROKE ALUMINUM RADIATOR PRE-INSTALL RADIATOR CHECKLIST



09. Check the cab isolators on the front of the vehicle. Perform a visual inspection to ensure that they are not worn or damaged (**Figure 9 and 10**). If they are worn, replace them prior to radiator installation.



PART REPLACEMENTS

10. Reference the factory part numbers below if any updates are necessary for your vehicle.

Ford Part Number	Description
9C3Z-8A080-AA	Degas Bottle (Single Port)
9C3Z-8101-B	Degas Bottle Cap
AC3Z-8260-A	Upper Radiator Hose
AC3Z-8286-A	Lower Radiator Hose
8C3Z-8B379-B	Venturi Tee
VC-7-B	Ford Premium Gold Coolant
0778-00592	Radiator Refiller
8C3Z-8575-D	Thermostat Assembly
7C3Z-8124-A	Upper Radiator Bushing

**You are now prepared to install
your '08 –'10 Ford 6.4L Powerstroke
Aluminum Radiator.**

CONTINUED ON FOLLOWING PAGE

04

'08 –'10 FORD 6.4L POWERSTROKE ALUMINUM RADIATOR

PARTS LIST AND INSTALLATION GUIDE



PARTS INCLUDED

1PC | MISHIMOTO PERFORMANCE ALUMINUM RADIATOR

2PC | LOWER MOUNTING BUSHINGS

8PC | M6 X 1.0 X 16MM FLANGE HEAD BOLTS

MOUNTING HARDWARE

TOOLS NEEDED

8MM SOCKET

RATCHET EXTENSION

10MM SOCKET

NEEDLENOSE PLIERS

11MM DEEP SOCKET

FLATHEAD SCREWDRIVER

13MM SOCKET

FORD-APPROVED COOLANT

UNIVERSAL SOCKET JOINT

FUNNEL

RATCHET

INSTALL TIME 3.5 HOURS

INSTALL DIFFICULTY

DISCLAIMER

- Raise vehicle only on jack stands or on a vehicle lift.
- Allow vehicle to cool completely prior to attempting installation.
- Do not run the engine or drive the vehicle while overheating; serious damage can occur.
- Please dispose of any liquids properly.
- Mishimoto is not responsible for any vehicle damage or personal injury due to installation errors, misuse, or removal of Mishimoto products.
- Mishimoto suggests that a trained professional install all Mishimoto products.

CAUTION

Never work on the cooling system when it is hot. The coolant temperature in the radiator can be considerably higher than boiling, and the system may be under pressure. Opening a cooling system that is hot or under pressure can result in serious injury. Always wait until the system has cooled completely before servicing it in any way.

INSTALL PROCEDURE

01. Disconnect the negative terminal on both batteries.
02. Locate the drain plug on the base of the radiator and allow all coolant to drain from the radiator. To speed up the draining process, remove the cap on the coolant reservoir.
03. Loosen the clamps on the upper cold-side intercooler pipe boot.
04. Loosen the clamps on the lower hot-side intercooler pipe boot.
05. Remove the two bolts from the top of the intercooler. (2x 10mm bolts)



06. Remove the intercooler from the truck.
07. Remove the six bolts that hold the upper radiator support to the truck. (6x 13mm bolts)
08. Remove the four bolts that hold the radiator to the upper radiator support. (4x 10mm bolts)

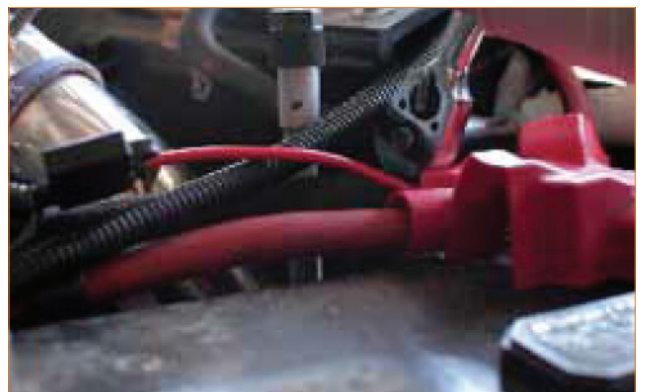

CONTINUED ON FOLLOWING PAGE

05

'08 –'10 FORD 6.4L POWERSTROKE ALUMINUM RADIATOR INSTALLATION GUIDE



09. Remove the bolt that holds the vehicle horns to the radiator support. (1x 10mm bolt)
10. Disconnect the hood release cable from its bracket.
11. Remove the upper radiator support from the truck, and set it aside.
12. Disconnect the power steering line from the radiator.
13. Remove the two bolts that hold the transmission cooler to the radiator. (2x 8mm bolts)
14. Disconnect the transmission lines from the radiator. Make sure to have a pan ready, as transmission fluid will drain.



15. Remove the two bolts that hold the AC condenser to the radiator. (2x 8mm bolts)
16. Remove the four pop clips that hold the lower side gaskets to the radiator. (4x pop-clips)
17. Remove the three pop clips that hold the upper gasket to the radiator. (3x pop-clips)
18. Remove the two bolts that hold the upper fan shroud to the radiator. (2x 8mm bolts)
19. Remove the two bolts that hold the lower fan shroud. (2x 8mm bolts)
20. Remove the two bolts that hold the power steering reservoir to the fan shroud. (2x 8mm bolts)



21. Remove the pop-clips that secure the upper gasket to the radiator. Remove the upper gasket. (3x pop-clips)
22. Unseat the battery lead, vacuum line and coolant overflow line from the radiator and move them back behind the fan shroud.
23. Remove the upper fan shroud from the radiator.
24. Disconnect the upper radiator hose.
25. Disconnect the lower radiator hose.
26. Carefully remove the radiator from the engine bay. Have someone help you with this, as the radiator is fairly large.
27. Install the new radiator bushings supplied with your kit.

Failure to install the provided Mishimoto lower radiator bushings will void the Mishimoto Lifetime Warranty.

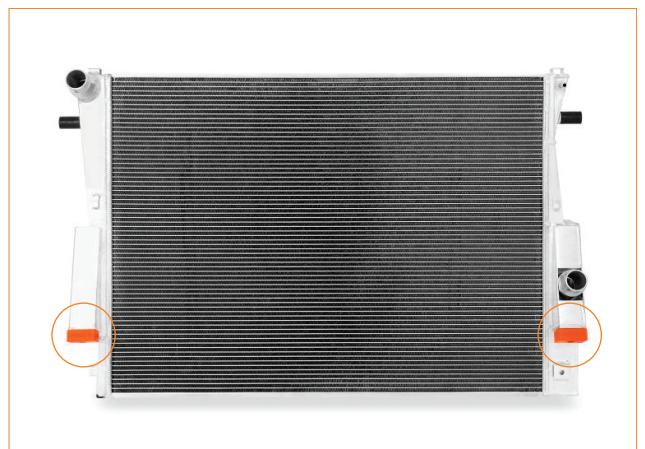

CONTINUED ON FOLLOWING PAGE

06

'08 –'10 FORD 6.4L POWERSTROKE ALUMINUM RADIATOR INSTALLATION GUIDE



- 28. Transfer the upper mounting clips from the factory radiator to the new Mishimoto radiator.
- 29. Position the Mishimoto radiator within the engine bay.
- 30. Reattach the upper and lower radiator hoses.
- 31. Using two bolts, reinstall the upper fan shroud to the radiator. (2x 8mm bolts)
- 32. Using two bolts, reattach the upper fan shroud to the lower fan shroud. (2x 8mm bolts)

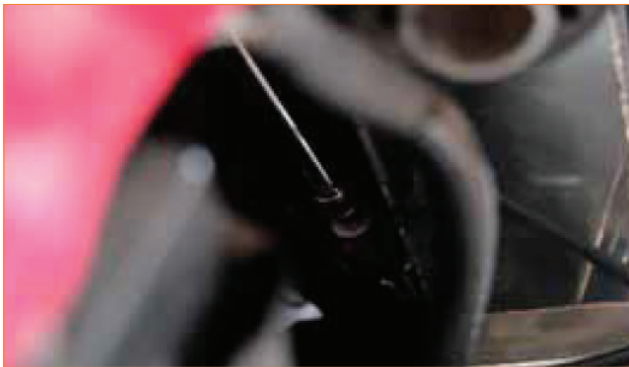

- 33. Reattach the battery lead, vacuum line and coolant overflow line and reinstall the upper gasket to the radiator. (3x pop-clips)



- 34. Reinstall the A/C condenser to the radiator, using two 8mm bolts.

- 35. Reinstall the transmission cooler and cooler lines to the radiator using two 8mm bolts.
- 36. Reattach the power steering reservoir to the fan shroud using two 8mm bolts.

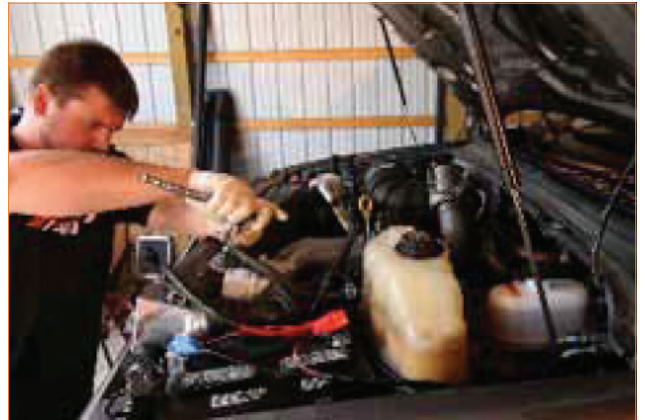

- 37. Reinstall the side gaskets on the radiator using four pop clips. Then reconnect the hood release cable to its bracket.
- 38. Reconnect the coolant reservoir hose.
- 39. Reattach the radiator to the radiator support using four 10mm bolts.



CONTINUED ON FOLLOWING PAGE

07

'08 —'10 FORD 6.4L POWERSTROKE ALUMINUM RADIATOR INSTALLATION GUIDE



- 40. Using six 13mm bolts, reattach the upper radiator support to the truck.
- 41. Reinstall the single 10mm bolt that holds the horns to the upper radiator support.



- 42. Reinstall the intercooler in the truck. Make sure that mounting pegs seat properly when installing.
- 43. Reattach the cold-side pipe boot to the intercooler.



- 44. Using two 10mm bolts, reinstall the top of the intercooler to the upper radiator support.
- 45. Reattach the lower hot-side pipe boot to the intercooler.



- 46. Refill the cooling system with a 50/50 mix of coolant and distilled water.



- 47. Reconnect the negative battery terminals on both batteries.
- 48. Start the vehicle and set the heat to high to purge any air from the cooling system. Allow the vehicle to reach operating temperature and check for any leaks in the system.
- 49. Fill the cooling system with premixed, Ford-approved coolant, start the engine, and allow it to idle with the expansion tank cap off. Turn the heat to full hot, and put the fan on low. Monitor the engine temperature and coolant level in the reservoir. Add coolant as needed to maintain a proper level in the reservoir, and check your connections for leaks. If the vehicle begins to overheat or coolant starts to overflow from the reservoir, shut the engine off and allow it to cool before continuing. Once the vehicle is fully warmed up and the coolant level has stabilized, allow the vehicle to cool off completely, and then top off the coolant level. Coolant level should be checked once more after putting in some miles.

Congrats! You just finished installing the '08 —'10 Ford 6.4L Powerstroke Aluminum Radiator.